



PARTS BREAKDOWN

HOT WATER PRESSURE WASHER

MODEL:HW4013HG



BEPOWEREQUIPMENT

.COM



PARTS BREAKDOWN

HOT WATER PRESSURE WASHER

MODEL:HW4013HG

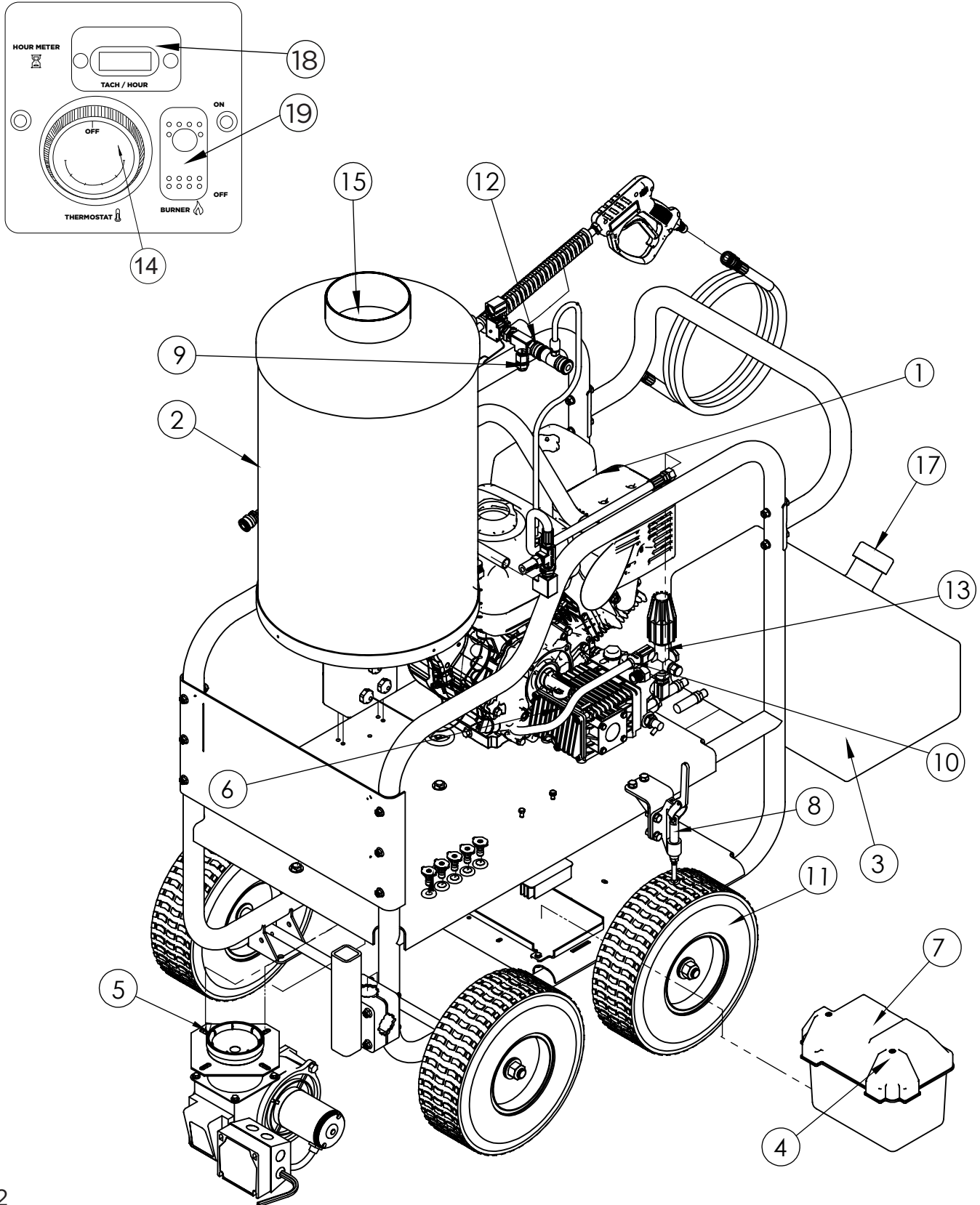



PARTS BREAKDOWN

HOT WATER PRESSURE WASHER

MODEL:HW4013HG

ITEM	PART NUMBER	DESCRIPTION	QTY.
1	Not for Resale	Honda GX390 Engine	1
2	59.000.100	Hot Water Coil Assy, 4 GPM	1
3	85.601.043	10 Gallon Fuel Tank	1
4	85.603.000	Battery	1
5	59.000.001	Burner Assy With Fuel Pump (Beckett, ADC-12V)	1
6	85.139.021H	Pump Assembly, GP EZ4040G	1
7	42.005.053	Battery Box	1
8	85.604.104	Brake Assembly	1
9	59.000.101	Safety Pressure Rupture Disc	1
10	85.300.082	Pressure Switch, 1/4" MNPT	1
11	85.660.050F	Wheel, 13" Flat Free	4
12	85.300.108S	Quick-Connect Coupler, 3/8" MNPT	1
13	AL607	Unloader, VRT3 4500 PSI	1
14	85.400.071	Thermostat (Temp Control)	1
15	59.000.116	Insulation, Bottom	1
	59.000.117	Insulation, Top	1
16	59.000.104	Fuel Filter	1
17	59.000.123	Fuel Cap	1
18	806-109	Tachometer	1
19	59.000.103	Toggle Switch	1
N/S	59.000.102	Low Voltage Inhibitor (LVI)	1
N/S	59.000.104	Diesel inline fuel filter	1

ACCESSORIES			
N/S	85.238.251	50' x 3/8" Double wire braided rubber hose	1
N/S	85.202.109	Hot water rated gun, 5000 PSI	1
N/S	85.202.026	36" Insulated wand	1
N/S	85.210.040H	Spray nozzle set: 0°, 15°, 40°, Soaper	1



PARTS BREAKDOWN

HOT WATER PRESSURE WASHER

MODEL:HW4013HG

ADC BECKETT BURNER

59.000.001

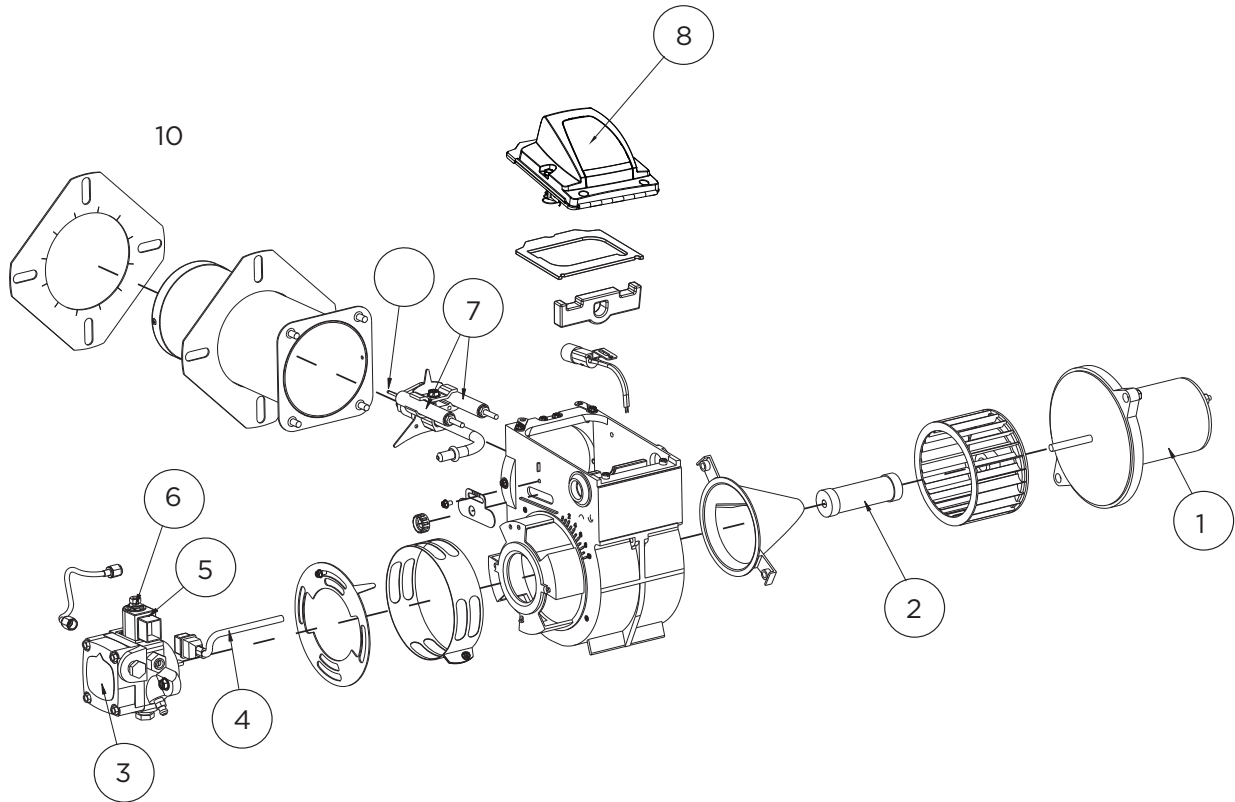

ITEM #.	PART #.	DESCRIPTION
1	59.110.004	BLOWER MOTOR
2	59.110.005	SHAFT COUPLING
3	59.110.000	FUEL PUMP
4, 5, 6	59.110.001	FUEL SOLENOID
7	59.110.002	ELECTRODE ASSEMBLY
8	59.110.003	IGNITER
9	59.000.002	FUEL NOZZLE
10	59.110.017	GASKET



PARTS BREAKDOWN

HOT WATER PRESSURE WASHER

MODEL:HW4013HG

PUMP

85.139.021H

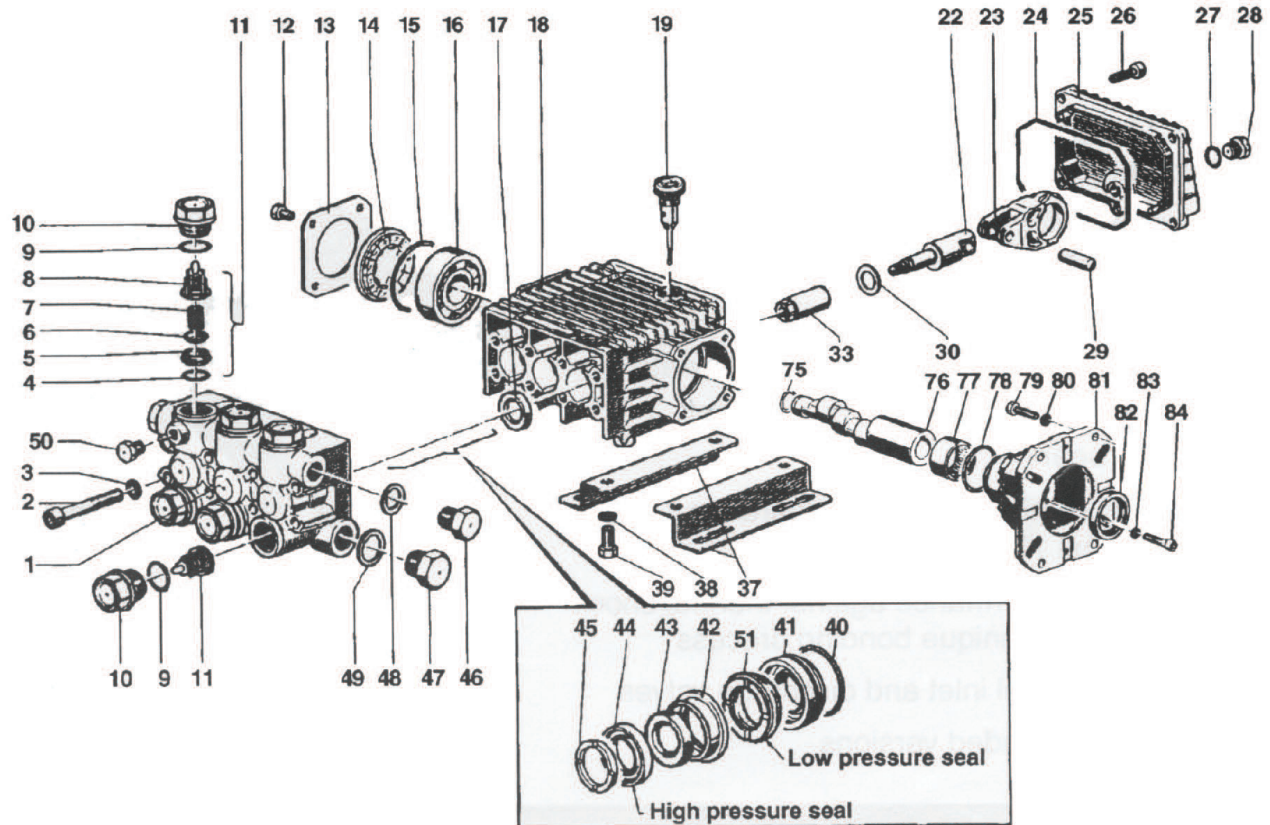

PARTS LIST

ITEM	PART NO.	DESCRIPTION	KIT NO.	QTY.	ITEM	PART NO.	DESCRIPTION	KIT NO.	QTY.	ITEM	PART NO.	DESCRIPTION	KIT NO.	QTY.
1.	44120641	Manifold		1	23.	44030022	Connecting Rod		3	48.	96738000	Washer		1
2.	99317500	Screw		8	24.	90392000	O-ring		1	49.	96751400	Washer		1
3.	96701400	Washer		8	25.	44160022	Rear Cover		1	50.	98196600	Cap Screw		1
4.	90384100	O-ring	123	6	26.	99183700	Screw		5	51.	90260300	Seal, Low Pressure	153,156	1
5.	36200366	Valve Seat	123	6	27.	90358500	O-ring		1	75.	90063500	Retaining Ring		1
6.	36200176	Valve	123	6	28.	98204100	Cap Screw		1	76.	44022165	Crankshaft (EZ4040G)		1
7.	94737600	Spring	123	6	29.	97734000	Pin		3	44021265	Crankshaft (EZ4035G34)		1	
8.	36202551	Valve Cage	123	6	30.	96696700	Washer		3	44020965	Crankshaft (EZ4030G34)		1	
9.	90384700	O-ring	124	6	33.	44040266	Plunger, 13 mm		3	77.	91856800	Roller Bearing		1
10.	98222600	Cap Screw	124	6	37.	50200074	Rail		2	78.	90409700	O-ring		1
11.	36711501	Valve Assembly	123	6	38.	96701600	Washer		4	79.	99275500	Screw, 5/16 x 1		4
12.	99180700	Screw		4	39.	99303700	Nut		4	99334500	Screw, 3/8 x 1		4	
13.	50150074	Bearing Cover		1	40.	90361200	O-ring	156	3	80.	96702000	Washer, 8 mm		4
14.	44211801	Spacer		1	41.	44080370	Packing Retainer	156	3	96710400	Washer, 10 mm		4	
15.	90409700	O-ring		1	42.	44216270	Intermediate Ring	156	3	81.	10051822	Gas Flange		1
16.	91832800	Ball Bearing		1	43.	90507600	Packing	153,156	3	82.	90169000	Oil Seal		1
17.	90161400	Oil Seal	23	3	44.	90260200	Packing	153,156	3	83.	96693800	Washer		4
18.	44010022	Crankcase		1	45.	44100251	Head Ring	156	3	84.	99191200	Screw		4
19.	98210300	Oil Dip Stick		1	46.	98210000	Cap Screw		1					
22.	44050166	Piston Guide		3	47.	98217600	Cap Screw		1					



PARTS BREAKDOWN

HOT WATER PRESSURE WASHER

MODEL:HW4013HG

WIRING DIAGRAM

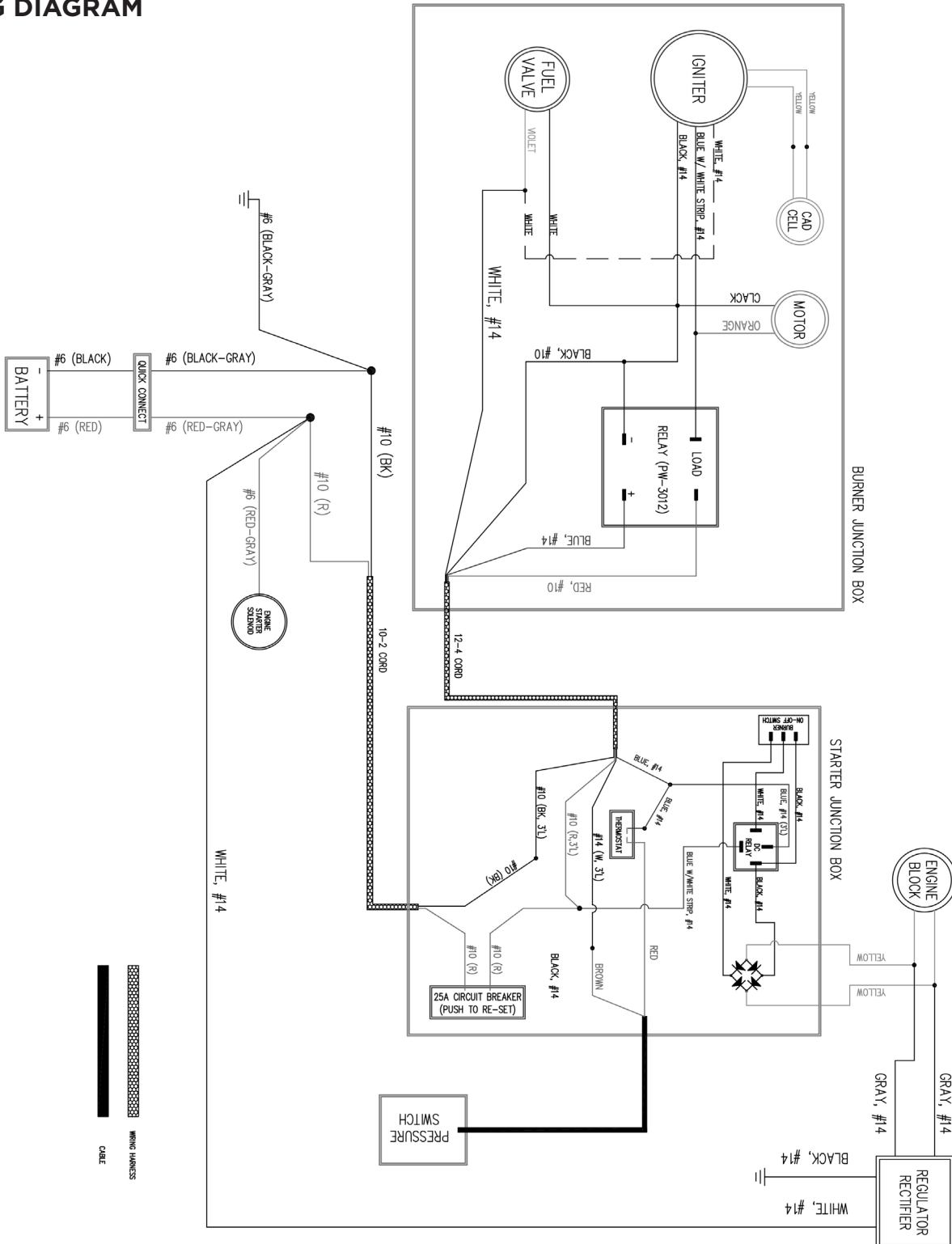

BE

POWER EQUIPMENT

If you need technical assistance call:

1-866-850-6662

(8:00am - 4:30pm PST, Mon - Fri)