

BE

COMMERCIAL

SERIES

NATURAL GAS HOT WATER WASHER



HW255E1CNG
HW255E3CNG
HW2775E1CNG
HW2775E3CNG

User Manual

85.610.594

BEPOWEREQUIPMENT

.COM



TABLE OF CONTENTS

Introduction & Product Info

3 Introduction & Production info

Important Safety Warnings

4 Important Safety Warnings & Symbols

Product Specifications

7 Specifications Chart

Before Starting The Unit

8 Pre-Operation Safety & Inspection Procedures

9 Combustion Air Supply

Start-Up & Shutdown Operations

10 Starting the Unit

10 Shutting down the Unit

Safety Components

11 Safety Components Specifications

Maintenance

12 Maintenance Chart

Storage & Winterizing

13 Storing the Unit

13 Winterizing the Unit

Parts Breakdown

14 5 HP units Breakdown

15 5 HP Phase units Parts Reference List

16 7 HP units Breakdown

17 7 HP Phase units Parts Reference List

Electrical Box Assembly

18 5 HP Electrical Box Assembly Breakdown

19 5 HP Electrical Box Assembly Parts
Reference List

20 7.5 HP Electrical Box Assembly Breakdown

21 7.5 HP Electrical Box Assembly Parts
Reference List

Wiring Diagrams

22 5 HP Wiring Diagram

23 7.5 HP Wiring Diagram

Coil Servicing

24 Coil Maintenance & Servicing

Warranty

25 Unit & Coil Warranty

Maintenance Notes

26 Notes



ATTENTION: Read through the complete manual prior to the initial use of your pressure washer.

Using the Operator's Manual

Thank you for purchasing our hot water pressure washer! This operating manual is an important part of the unit. It should be read thoroughly before initial use, and referred to often to make sure adequate safety and service concerns are being addressed.

Reading the owner's manual thoroughly will help avoid any personal injury or damage to your pump, engine, and other components. By knowing how best to operate this machine you will be better positioned to show others who may also operate the unit.

You can refer back to the manual at any time to help troubleshoot any specific operating functions, so store it with the machine at all times.

Product Registration

Please register your product online to get the maximum benefit from your warranty. Use the QR code below or register online at: bepowerequipment.com/product-registration



It is recommended that you record the product identification numbers in this manual. These numbers are important to have on hand if you need to contact technical support **(1-866-850-6662)**. The model and serial number can be found on the box and on decal on the machine.

PRODUCT IDENTIFICATION

Model Number: _____

Serial Number: _____

Date of Purchase: _____

Dealer Name: _____

PRODUCT SPECIFICATIONS

MODEL	GPM	PSI	HP	PHASE	MOTOR	VOLT	PUMP	UNIT WEIGHT	SHIPPING DIMS
HW255E1CNG	3.5	2500	5	1	BALDOR	240V	COMET	598lbs	51" x 35" x 57"

MODEL	GPM	PSI	HP	PHASE	MOTOR	VOLT	PUMP	UNIT DIMS	SHIPPING DIMS
HW255E3CNG	3.5	2500	5	3	BALDOR	240V	COMET	568lbs	51" x 35" x 57"

MODEL	GPM	PSI	HP	PHASE	MOTOR	VOLT	PUMP	UNIT DIMS	SHIPPING DIMS
HW277E1CNG	4.6	2700	7.5	1	BALDOR	240V	COMET	675lbs	51" x 35" x 57"









MODEL	GPM	PSI	HP	PHASE	MOTOR	VOLT	PUMP	UNIT DIMS	SHIPPING DIMS
HW277E3CNG	4.6	2700	7.5	3	BALDOR	240V	COMET	628lbs	51" x 35" x 57"



This is the safety alert symbol. It is used to alert you to potential personal injury hazards. Obey all safety messages that follow this symbol to avoid possible injury or death.

DANGER	This indicates a hazard which, if not avoided, will result in serious injury or death.
WARNING	This indicates a hazard which, if not avoided, will result in a severe injury or property damage.
CAUTION	This indicates a hazard which, if not avoided, might result in a minor or moderate injury.
NOTICE	This indicates a situation that could result in equipment damage or damage to other property. Ensure all safety messages are observed and adhered to.

Hazard Symbols and Meanings

			
EXPLOSION	FIRE	HOT SURFACE	MOVING PARTS
			
FLYING OBJECTS	ELECTRIC SHOCK	TOXIC FUMES	INJECTION

DANGER

- Always operate the pressure washer in a well-ventilated area free of flammable vapors, combustible dust, gases, or other combustible materials.
- Do not store the pressure washer near an open flame or any equipment such as a stove, furnace, water heater, etc., which utilizes a pilot light or sparking device.
- Do not use this pressure washer to spray flammable material.
- Do not smoke while filling burner fuel tank.
- Never fill the fuel tanks while the pressure washer is running or hot. Allow unit to cool for two minutes.
- Always refuel slowly to avoid the possibility of spilled fuel which may cause a risk of fire.
- Always leave room for fuel to expand in the gas tank. Do not overfill.
- Engine Fuel Tank: If using a Gasoline Engine, refuel with gasoline only. Do not use diesel or kerosene.
- Burner Fuel Tank (Black): When refueling the Burner Fuel Tank, use No. 1 or No. 2 fuel oil/diesel or kerosene. Do not use gasoline.
- Do not operate the unit if gasoline or diesel fuel is spilled. Wipe the pressure washer clean and move it away from the spill. Avoid creating any ignition until the gasoline or diesel fuel has evaporated.
- When the battery is being activated, hydrogen and oxygen gases in the battery are extremely explosive. Keep open sparks and flames away from the battery at all times, especially when charging.
- Be certain to disconnect the battery ground terminal before servicing. When disconnecting the cable from the battery, start with the negative terminal. When connecting them, start with the positive cable.
- When charging the battery, remove the battery vent plugs.
- Use only a voltmeter or hydrometer to check a battery charge.
- DO NOT jump start the battery unless both batteries are of equal voltage and amperage.

IMPORTANT SAFETY WARNINGS



WARNING



Serious injury or death may occur from a fire caused by a muffler spark.

Serious injury or death may occur if system safety's are not properly maintained.

- A spark arrester must be added to the muffler of this engine when using on land covered with any flammable agricultural crop (hay and grain), and if they are used in or near brush or forested areas. The arrester must be maintained in effective working order by the operator of the equipment. In the state of California, the above is required by law. (Section 4442 and 4443 of the California Public Resources Code.) Other states/provinces may have similar laws. Federal laws apply on Federal lands.
- This pressure washer has a Safety Relief Valve . This should never be altered, modified, removed or made inoperative. If the device fails, replace immediately with genuine manufacturer replacement part.

WARNING



Serious injury or death may occur from inhaling engine/burner exhaust or dangerous vapors. The engine exhaust from this product contains chemicals known to the State of California to cause cancer, birth defects, or other reproductive harm.

- Never operate this pressure washer in an enclosed area. Always ensure there is adequate ventilation (fresh outside air) for breathing and combustion. This will prevent the buildup of dangerous carbon monoxide gases. Beware of poorly ventilated areas, or areas with exhaust fans which can cause poor air exchange. This unit should only be used outdoors to ensure ventilation is never an issue.
- Follow all safety instructions provided with the materials you are spraying. Use of a respirator may be required when working with some materials. Do not use this pressure washer to dispense hazardous detergents.

WARNING



Serious injury or death could occur from high pressure spray penetrating the skin.

- Keep clear of nozzle and spray! Never put your hand, fingers or body directly over the spray nozzle.
- Do not direct discharge stream at self, other persons, or pets.
- This product is to be used only by trained operators.
- Always keep operating area clear of other people.
- Do not allow children to operate this unit or be in the vicinity while you operate it.
- Seek emergency medical care if spray seems to have penetrated the skin. Do not treat as a simple cut!
- High pressure hoses and fuel lines should be inspected daily for signs of wear. If evidence of failure exists, promptly replace all suspect hoses and fuel lines to prevent the possibility of injury from the high pressure spray. If a hose or fitting is leaking, do not place your hand on the leak.
- Never operate the gun with the trigger held in the open position. To prevent accidental discharge, the trigger gun should be securely locked when not in use.
- Before removing the spray nozzle or servicing the unit, always shut the unit off and pull the trigger of the gun to release trapped pressure (even after you shut off the unit, there is high pressure water left in the pump, hose and gun until you release it by pulling the trigger the gun).

WARNING



Serious injury or death may occur from contact with electricity.

- Do not direct spray on or into electrical installations of any kind! This includes electrical outlets, light bulbs, fuse boxes, transformers, and the unit itself.
- Do not allow metal components of the pressure washer to come in contact with live electrical components.

WARNING



Serious injury may occur from touching the gasoline engine, muffler, or heat exchanger. These areas can remain hot for some time after the pressure washer is shutdown.

- Never allow any part of your body to contact the gasoline engine, muffler, or heat exchanger.

WARNING



Serious injury may occur from a pressure washer malfunction or exploding accessories if incorrect system components, attachments, or accessories are used.
Serious injury or death may occur if attempting to start the pressure washer when the pumping system is frozen.

- Never make adjustments to the factory set pressures.
- Never exceed manufacturers maximum allowable pressure rating of attachments.
- Do not allow any hoses to make contact with heat exchanger to prevent the possibility of bursting. Avoid dragging the hoses over abrasive surfaces such as cement.
- Use only manufacturer recommended repair parts for your pressure washer.
- In freezing temperatures, the unit must always be warm enough to ensure there is no ice formation in the pump. Do not start the pressure washer if it has been transported in an open or under heated vehicle without first allowing the pump to thaw.

WARNING



Serious injury may occur to the operator from moving parts on the pressure washer.

- Before making any adjustments, be certain the engine is turned off and the ignition cable(s) is removed from the spark plug(s). Turning the machinery over by hand during adjustment or cleaning might start the engine and machinery with it.
- Do not operate the unit without all protective covers in place.

WARNING



Serious injury or death may occur from detergents contacting the skin.
Serious injury can occur from loose debris being propelled at a high speed from the spray gun.
Injury may occur if the operator loses their balance caused by the thrust of water traveling through the spray nozzle.

- Never use any solvents or highly corrosive detergents or acid type cleaners with this pressure washer.
- Protective equipment such as rubber gloves and respirators are advisable, especially when using cleaning detergents.
- Keep all detergents out of the reach of children!
- Always wear protective goggles when operating the unit to shield the eyes from flying debris and detergents.
- Do not direct spray toward fragile materials such as glass.
- Stay alert: watch what you are doing. Do not operate the unit when fatigued or under the influence of alcohol or drugs.
- Never squeeze the trigger unless securely braced.
- Do not overreach or stand on unstable support.
- Wet surfaces can be slippery. Wear protective foot gear and keep good footing/balance at all times.
- Never pull the trigger of the gun while on a ladder, roof, or other unstable surface.
- Always hold on firmly to the gun/lance assembly when starting and operating the unit. Failure to do so can cause the lance to fall and whip dangerously.
- Do not leave pressurized unit unattended. Shut off the pressure washer and release trapped pressure before leaving.
- Do not operate the unit if you see any fuel, oil, or water leaking from the machine. DO NOT resume operation until the unit has been inspected and repaired by a qualified technician.
- Do not transport the unit by pulling on hoses or cords.

WARNING

If you smell gas, shut off the gas supply to the appliance, extinguish any open flame, and test all joints with a soap solution. If the odor persists, call your gas supplier immediately.

UNIT SPECIFICATIONS



MODEL		HW255E1CNG	HW255E3CNG	HW2775E1CNG	HW2775E3CNG
HEATER	PSI & GPM	2500 @3.5 GPM	2500 @3.5 GPM	2700 @4.6 GPM	2700 @4.6 GPM
	BTU's	345,500	345,500	345,500	345,500
SPECIFICATIONS	INPUT PRESSURE NG	7 INCHES	7 INCHES	7 INCHES	7 INCHES
	MANIFOLD PRESSURE NG	2.6 INCHES	2.6 INCHES	2.6 INCHES	2.6 INCHES
	INPUT PRESSURE PROPANE	14 INCHES	14 INCHES	14 INCHES	14 INCHES
	MANIFOLD PRESSURE PROPANE	10 INCHES	10 INCHES	10 INCHES	10 INCHES
	ORIFICE SIZE	#53NG or #65LP	#53NG or #65LP	#53NG or #65LP	#53NG or #65LP
SAFETY COMPONENTS	Thermostat	YES	YES	YES	YES
	Flow Switch	YES	YES	YES	YES
	High Temp Limit Protector	YES	YES	YES	YES
	High Pressure Relief Valve	YES	YES	YES	YES
	Dimensions (LxWxH) in.	43"x20"x42"	43"x20"x42"	43"x20"x42"	43"x20"x42"
	DRAFT HOOD SIZE (diameter)	9"	9"	9"	9"
	Weight (pounds)	598	568	675	628



BEFORE STARTING THE UNIT

When unpacking the unit, if you find damage due to shipping, contact your dealer or BE Power Equipment immediately.

ELECTRICAL SUPPLY

Arrange with an electrician to install a properly grounded, three wire receptacle.

To protect the receptacle from splashes, the recommended height above the ground level is a minimum of four feet. Make sure the supply voltage is correct. The voltage is shown on the rating plate of the unit, or see "Specifications, Features and Options" sheet in this manual.

WARNING

DO NOT CHANGE THE AC PLUG ON THE UNIT TO A DIFFERENT TYPE.
DO NOT CUT OFF THE GROUND PIN OR THE OPERATOR WILL BE EXPOSED TO SEVERE SHOCK. KEEP ELECTRICAL CORDS AND CONNECTIONS DRY AT ALL TIMES.

INCOMING WATER SUPPLY

Connect a garden hose to the water inlet of the unit. The water supply must be able to deliver from 5 to 6.5 gallons per minute at a minimum pressure of 5 psi. See the "Specifications, Features and Options" sheet in this manual.

OUTGOING (HIGH PRESSURE) WATER

To the water outlet fitting, connect the high pressure hose, trigger gun, extension and nozzle. (The nozzle is located in a plastic bag with this manual.)

PUMP - OIL

Before operating the pump, check to see that the oil is level with the dot on the sight gauge which is located at the rear of the pump. The oil level can also be checked using the dipstick which is attached to the oil filler cap. Ensure that the vent hole in the cap/dipstick is clear of dirt. When oil is required, use #20 or #30 non-detergent heavy duty oil.

ENGINE - OIL

Refer to the Engine Manual.

FUEL SUPPLY

For stationary installations, have the gas piping installed by a licensed gas fitter. This must be done in accordance with the gas codes;

B149.1 for Natural Gas

B149.2 for Propane Gas

For portable machines, connect the supply hose and regulator into the POL fitting in the valve on the supply tank. Remember that this fitting has a left hand thread. Open the tank valve and check for leaks in the propane connections with a soap solution. Depress the pilot valve for approximately a minute to purge the lines of air. Wait 5 minutes to allow any escaped propane to dissipate before lighting the pilot.

CAUTION

Propane gas is heavier than air and can collect in low hollow areas in an explosive mixture. Ensure that the areas where you operate this machine are open to breezes, etc.

DETERGENT SUPPLY

Only use chemicals with a pH between 7.0 and 10.0. For stronger chemicals, use a Down Stream injection system. Contact your dealer for additional information.

PROTECT FROM FREEZING

When transporting or storing your pressure washer at temperatures below freezing, make sure that the unit has been properly winterized. (See Winterizing Your Pressure Washer).

Even an overnight frost can split a coil or crack a pump.

COMBUSTION AIR SUPPLY

The 5004N/P heater is comprised with an Atmospheric burner and requires air for combustion and ventilation. The appliance installer will know how and where to place a supply air duct. Take care that this opening will not promote drafts which could blow out the pilot light. Keep the area around the machine clear so this air can get to the burner.

APPLIANCE IN CONFINED SPACE

The confined space shall have two permanent openings: one near the top of the enclosure and one near the bottom of the enclosure. Each opening shall have a free area of not less than one (1) square inch per 4000 BTU's per hour of the total input of all appliances within the enclosure. The openings shall have free access to the room interior which should have adequate infiltration from the outside.

OUT DOOR ROOF STACK SPACING REQUIREMENTS

Must Conform to local standards. Below drawing is a Guide.

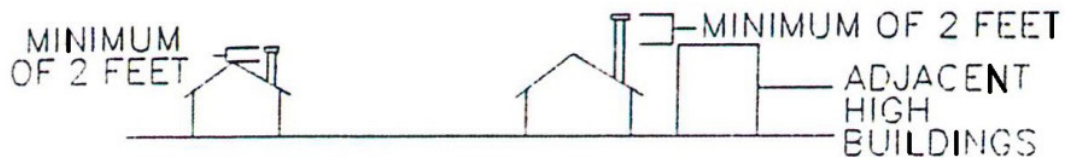



STARTING & SHUTTING DOWN THE PRESSURE WASHER

WARNING

Never run the washer without water.

STARTING THE MACHINE

- 1) Turn gas supply valve “ON”
- 2) Turn control valve “ON”

CAUTION

The force of the water leaving the nozzle causes a kick-back or recoil at the trigger gun.

START UP

- 1) Make sure that switches are “OFF”
- 2) Connect electrical supply
- 3) Connect machine to water supply
- 4) Connect high pressure hose gun and wand to outlet of pressure washer
- 5) Grasp gun firmly and turn “pump” switch “ON”
- 6) When spray is constant turn on “burner” switch “ON” then turn thermostat to desired temperature

SHUTDOWN

- 1) Turn “burner” switch off
- 2) Pump cold water through spray gun for two minutes
- 3) Shut off “pump” and activate spray gun to release pressure in the line
- 4) Shut off gas supply valve if machine is to be left for long periods of time

CHANGING PRESSURE

The variable Unloader Valve is already set to full pressure. Do not adjust the Unloader past the maximum pressure, as this will not increase the performance, and the excessive shut-off pressure will damage the Washer.

CLEANING CHEMICALS

For chemical application, a chemical injector is required. Open the valve at the lance. To change concentration, adjust metering valve toward open or close. Use only chemicals with a pH between 7.0 and 10.0. For stronger chemical, use a Downstream Injection System. (Contact dealer for details.)

CAUTION

After you use chemical additives, thoroughly **FLUSH** the system with clean water.

FLOW SWITCH

The flow switch prevents the burner from being turned on if there is insufficient water. Proper water flow causes the magnetic core to be pushed up, closing the reed contact. This contact is interlocked with the gas control valve.

UNLOADER VALVE

The Unloader Valve allows all of the water delivered by the pump to return to the pump suction side. If the trigger gun is closed or “OFF”, the Unloader Valve goes into the “bypass mode” and the pump runs without pressure. However, **the pump may be severely damaged, due to excessive overheating, if left running in the “bypass mode” or “gun-off” situation for more than 6 minutes.**

SAFETY RELIEF VALVE

The Relief Valve prevents the machine from being subjected to abnormally high pressures. If this situation occurs, the valve will blow off relieving the pressure in the coil. This valve may also operate if the unloader is adjusted too high.

PRESSURE SWITCH

The Pressure Switch ensures that there is pressure, and therefore there is water flow at the head of the pump. This control does not operate at less than 300 psi. Therefore if the pump is on “bypass mode”, the burner will not operate. Also, if the Unloader is turned back less than 300 psi in the steam mode, the burner will not operate. The effect of this switch is very similar to that of the flow switch.

THERMOSTAT

The built-in thermostat stops the unit from overheating. Maximum temperature of the unit is 230°F. (110°C) Above this temperature, the burner stops automatically.

HIGH LIMIT SWITCH

The High Limit Switch is a thermostat which operates at a higher temperature than the built-in thermostat, about 300°F. (150°C.) This switch is not adjustable and will only operate when other controls fail to keep the water temperature within the normal operating range. Unlike the other burner control switches, this switch cuts the power to the whole gas valve, not just the gas solenoid.

COMBINATION AUTOMATIC GAS VALVE

The gas valve incorporates a manual shut-off valve, a gas regulator, the pilot control and a timed automatic shut-off. The functions of the manual shut-off and regulator are simple. The manual shut-off closes the gas inlet so that no gas can enter the burner. The regulator regulates the flow of gas to keep it at constant pressure. The pilot control is a pilot control valve and thermocouple sensor. The pilot valve can be opened to light the pilot burner. When lit, the burner flame is directed to a thermocouple sensor. The sensor heats up from the flame and allows the pilot valve to stay open permitting automatic operation of the burner. If the pilot goes out, the thermocouple will cool down and the control will shut-off the gas supply. The pilot must then be manually relit.



MAINTENANCE SCHEDULE

PROCEDURE	DAILY	3 MONTHS	6 MONTHS	9 MONTHS	12 MONTHS
Check engine oil level (ONLY use the type and grade of oil specified for this pump.)	X				
Change engine oil*****		X	X	X	X
Check water pump oil level	X				
Change water pump oil **		X	X	X	X
Oil leak inspection	X				
Fuel leak inspection	X				
Water leak inspection	X				
Hose inspection	X				
Water inlet screen inspection	X				
Check fuel filter		X	X	X	X
Replace fuel filter			X		
Inspect belts		X	X	X	X
Replace high pressure nozzle***		X	X	X	X
Inspect fuel pump filter*					X
Replace fuel nozzle*					X
Check burner air adjustment		X	X	X	X
Check burner electrodes*					X
Test water pressure*		X	X	X	X
Test fuel pressure*		X	X	X	X
Test water temperature*		X	X	X	X
Descale coil****					X
Power Cord/Outlet Socket inspection (replace worn or damaged parts immediately)	X				

* Must be performed by an authorized service technician.

** The pump oil must be changed after the first 50 hours of operation and then every 250 hours or 3 months, whichever comes first.

*** High pressure nozzle should be replaced whenever pressure drops to less than 85%.

**** Scale build-up will vary with mineral content in the water and amount of usage. Descaling can range from weekly to yearly maintenance.

***** The engine oil must be changed after the first 8 hours of operation and then every 50 hours or 3 months, whichever comes first.

STORAGE & WINTERIZING

When storing the unit for winter, it is important to ensure it is stored in the right environment. Ensure the storage area stays above freezing during cold weather, and try to limit the amount of dust gathered on the unit via a cover.

STORING WITH A FLOAT BOX

- Shut off the water supply, and disconnect hose.
- Remove cover from Float Box.
- Run the pressure cleaner until the level of the water in the Float Box is just above the outlet screen.
- Turn off the cleaner.
- Fill the Float Box to about 3/4 with windshield washer or antifreeze.
- Turn on the cleaner and open gun until liquid comes out of nozzle “foamy” or “soapy”.

CAUTION

If your hose is longer than 35 feet, the float box may empty before the liquid from the nozzle gets foamy. If this happens, refill the float box with antifreeze into bypass line.

- Put gun in OFF position for five seconds to allow antifreeze into bypass line.
- Shut off motor - unit is now winterized.

STORING WITHOUT A FLOAT BOX

- Shut off the water supply and disconnect hose.
- You need a short (2”) length of hose with a male garden hose fitting on one end.
- Connect the short hose to the inlet of the machine.

- Put the other end of the hose into a container of windshield washer or antifreeze.
- Turn on Cleaner and open gun until liquid comes out of nozzle “foamy” or “soapy”.
- Put gun in OFF position for 5 seconds to get antifreeze into bypass line. Shut off motor. The unit is now winterized.

- BE **“Pump Saver”** Solution (P/N: 85.490.046). This is an anti-freeze solution that is used before storing the unit. It coats to inside of the pump to ensure that any residual water doesn’t freeze. To use BE Pump Saver, follow the instructions written on the bottle. Water freezing in the pump will damage seals and other internal parts. **Freezing damage is not covered by warranty.**

- BE **“Pump & Coil Blowout Tool”** (P/N: 59.400.000). This tool utilizes compressed air to forcefully remove any water left in the pump. One end of the tool attaches to an air compressor, while the other attaches to the inlet of your water pump via an adapter. Follow the instructions on the back of the packaging to use the Pump and Coil Blowout Tool.

CAUTION

Be certain the hoses and spray gun are not attached to the pump during application of pump saver or use of the blowout tool. Having a hose attached greatly reduces the amount of water/debris removed from the pump and coil.



UNIT BREAKDOWN

HW255E1CNG
HW2775E1CNG



PARTS REFERENCE LIST



HW255E1CNG

HW2775E1CNG

ITEM	PART NUMBER	DESCRIPTION	QTY.
1	HE X44-65	BURNER RING	1
2	HE X44-53	BURNER RING	1
3	HE 36C68-423B	GAS VALVE ELECTRONIC IGNITION- PILOT RELIGHT	1
4	HE S861041003	ELECTRONIC IGNITION MODULE	1
5	Q3451ASSY	PILOT BURNER ASSEMBLY	1
6	36H32-423	24V ELECTRONIC IGNITION GAS VALVE	1
7	S8610H3018	IGNITION MODULE	1
8	RU500B-1T	RELIEF VALVE	1
9	PUST5	FLOW SWITCH	1
10	85.300.097	CHEMICAL INJECTOR	1
11	T44110	HI LIMIT	1
12	24606	BOTTOM PAN	1
13	70.001.005	230V, 5HP MOTOR (HW255E1CNG)	1
14	70.001.075	230V, 7.5HP MOTOR (HW2775E1CNG)	1
15	24601	BASE	1
16	85.300.037	UNLOADER	1
17	85.149.017B	COMET FWS23530E, TRIPLEX, 3000 PSI 5HP PUMP (HW255E1CNG)	1
18	85.0149.033B	COMET FWS2, TRIPLEX, 3000 PSI 7.5HP PUMP (HW2775E1CNG)	1
19	85.300.056	WATER INLET ASSEMBLY	1
20	FIA59LD36A	CONNECTOR HOSE	1
21	40362	DRAFT HOOD	1
22	40168	HEATING COIL	1
23	246115	S.S. COIL SKIN	1
24	24609	COIL CAP	1
25	85.210.045BEP	5 HP QUICK CONNECT SPRAY NOZZLE 45	1
26	85.210.055BEP	7.5 HP QUICK CONNECT SPRAY NOZZLE 55	1
27	85.238.251	50FT 6000 PSI 3/8" RUBBER HOSE	1
28	85.205.064	36" GUN AND WAND ASSEMBLY	1

HW255E3CNG
HW2775E3CNG



PARTS REFERENCE LIST



HW255E3CNG

HW2775E3CNG

ITEM	PART NUMBER	DESCRIPTION	QTY.
1	HE X44-65	BURNER RING	1
2	HE X44-53	BURNER RING	1
3	HE 36C68-423B	GAS VALVE ELECTRONIC IGNITION- PILOT RELIGHT	1
4	HE S861041003	ELECTRONIC IGNITION MODULE	1
5	Q3451ASSY	PILOT BURNER ASSEMBLY	1
6	36H32-423	24V ELECTRONIC IGNITION GAS VALVE	1
7	S8610H3018	IGNITION MODULE	1
8	RU500B-1T	RELIEF VALVE	1
9	PUST5	FLOW SWITCH	1
10	85.300.097	CHEMICAL INJECTOR	1
11	T44110	HI LIMIT	1
12	24606	BOTTOM PAN	1
13	70.003.005	230V/460V, 5HP MOTOR (HW255E3CNG)	1
14	70.003.075HE	230V/460V, 7.5HP MOTOR (HW2775E3CNG)	1
15	24601	BASE	1
16	85.300.037	UNLOADER	1
17	85.149.017B	COMET FWS23530E, TRIPLEX, 3000 PSI 5HP PUMP (HW255E3CNG)	1
18	85.0149.033B	COMET FWS2, TRIPLEX, 3000 PSI 7.5HP PUMP (HW2775E3CNG)	1
19	85.300.056	WATER INLET ASSEMBLY	1
20	FIA59LD36A	CONNECTOR HOSE	1
21	40362	DRAFT HOOD	1
22	40168	HEATING COIL	1
23	246115	S.S. COIL SKIN	1
24	24609	COIL CAP	1
25	85.210.045BEP	5 HP QUICK CONNECT SPRAY NOZZLE 45	1
26	85.210.055BEP	7.5 HP QUICK CONNECT SPRAY NOZZLE 55	1
27	85.238.251	50FT 6000 PSI 3/8" RUBBER HOSE	1
28	85.205.064	36" GUN AND WAND ASSEMBLY	1

HW255E1CNG
HW2775E1CNG

CONTACTOR
(REFER TO CHART ON PAGE 19)

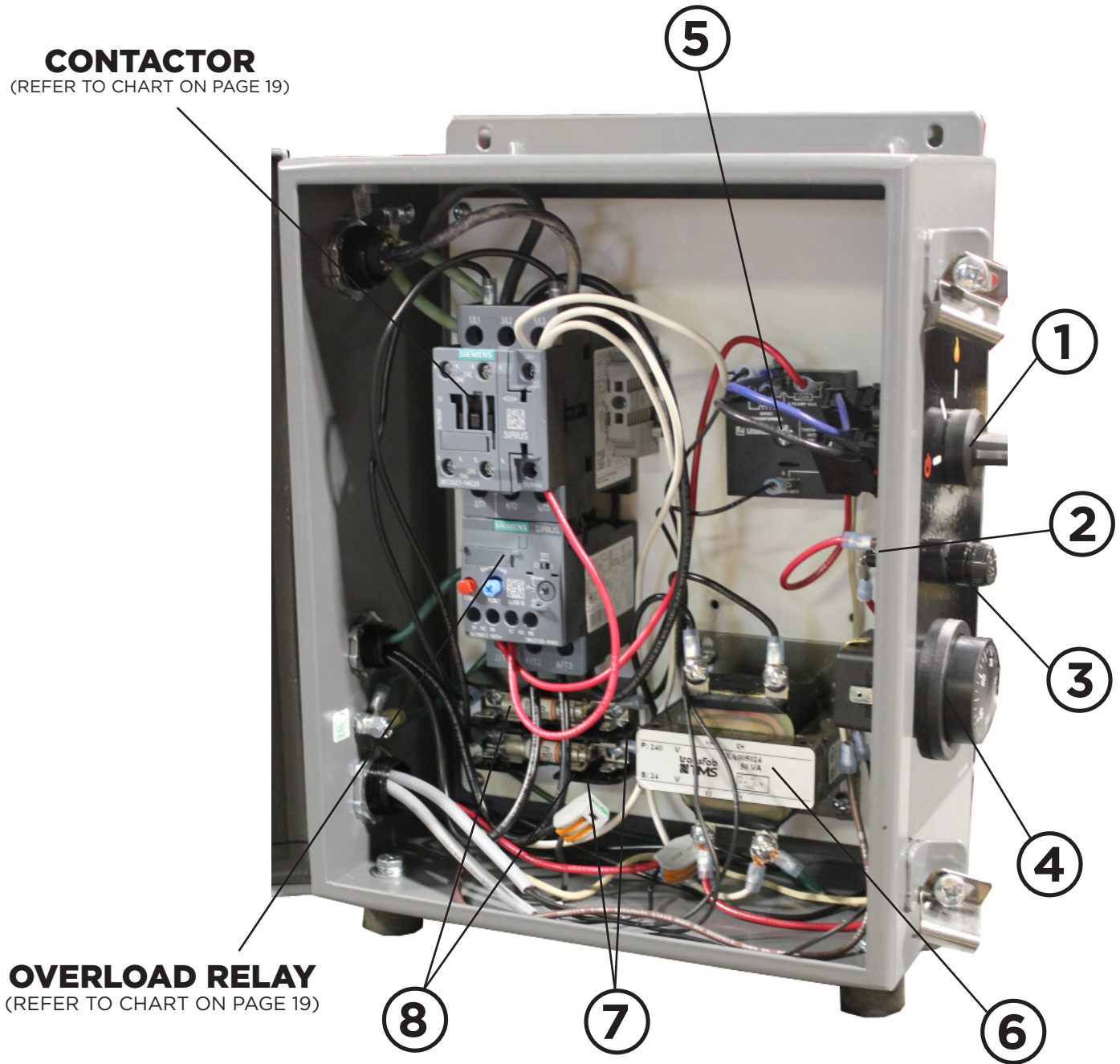

PARTS REFERENCE LIST



HW255E1CNG
HW2775E1CNG

ITEM	PART NUMBER	DESCRIPTION	QTY.
1	ELCA7	ROTARY SWITCH PUMP/BURNER	1
2	EL345603	SHOCKSAFE FUSEHOLDER 1/4x1.25	1
3	ELGGC5	1/2 AMP GLASS FUSE	1
4	ELTR86	OFF-120 DEGREES THERMOSTAT	1
5	ELCT1S30	CT1S30 OFF DELAY TIMER SSAC	1
6	ELMH50AG	600/24V 50A TRANSFORMER	1
7	EL6M30A2SQ	600V 30A 2POLE FUSE HOLDER	1
8	ELATDR1/2	TIME DELAY FUSE 600V 1/2A	1

ELECTRICAL CONTACTOR AND OVERLOAD PARTS LIST

PART NO.	PHASE	MOTOR (HP)	VOLTAGE (V)	CONTACTOR PART NO.	OVERLOAD PART NO.
HW255E1CNG	1	5	230	ELCI-32	ELT9E1/23-28
HW2775E1CNG		7.5	230	EL42CF35AJ	ELT9E1/28-40

HW255E3CNG
HW2775E3CNG

CONTACTOR

(REFER TO CHART ON PAGE 21)

OVERLOAD RELAY

(REFER TO CHART ON PAGE 21)

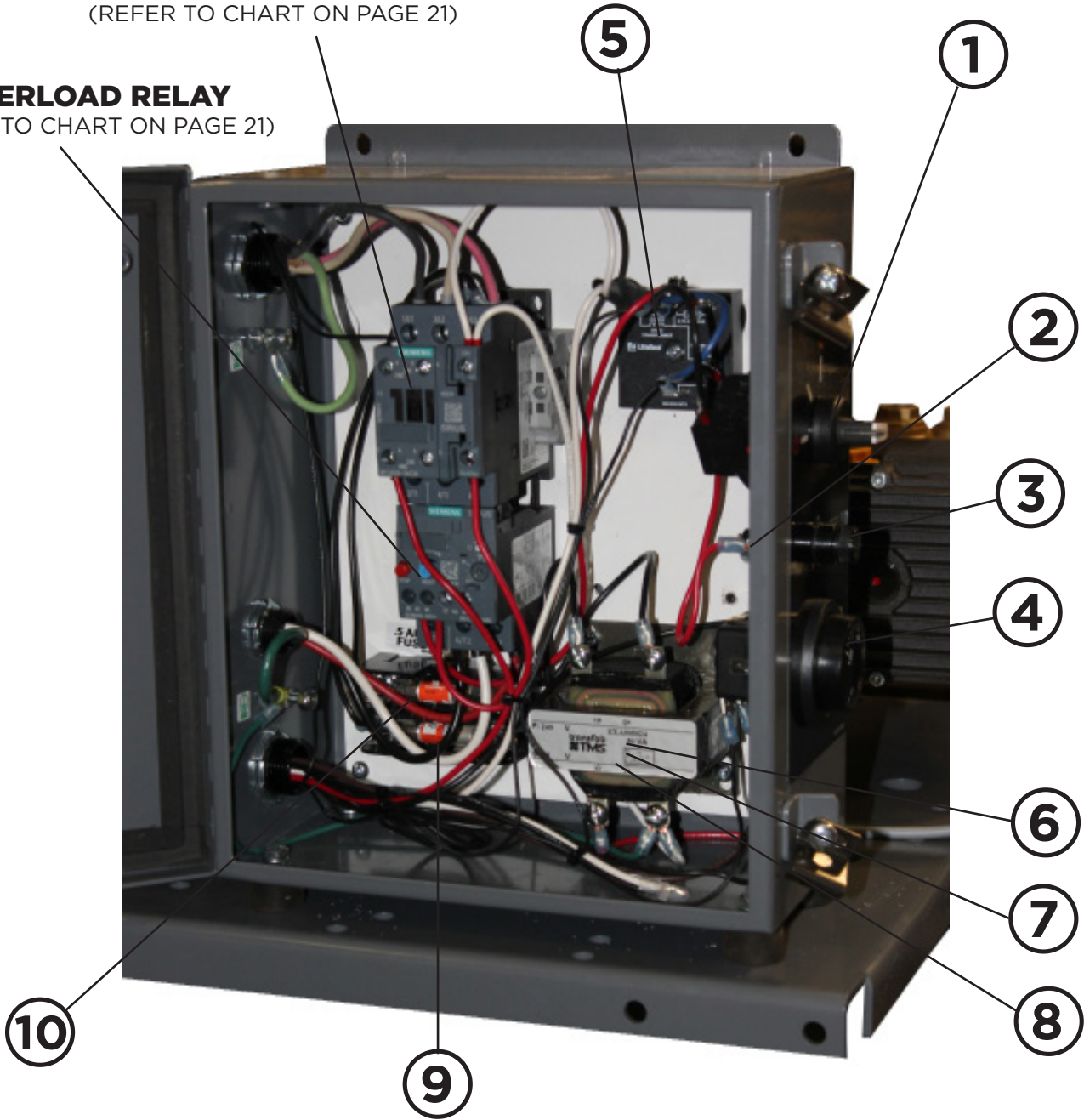

PARTS REFERENCE LIST



HW2775E3CNG

HW255E3CNG

ITEM	PART NUMBER	DESCRIPTION	QTY.
1	ELCA7	ROTARY SWITCH PUMP/BURNER	1
2	EL345603	SHOCKSAFE FUSEHOLDER 1/4x1.25	1
3	ELGGC5	1/2 AMP GLASS FUSE	1
4	ELTR86	OFF-120 DEGREES THERMOSTAT	1
5	ELCT1S30	CT1S30 OFF DELAY TIMER SSAC	1
6	ELMH50MG	50VA 240-24V 60Hz TRANSFORMER	1
7	ELMH50CG	480-24V 50VA TRANSFORMER	1
8	ELMH50AG	600-24V 50VA TRANSFORMER	1
9	EL6M30A2SQ	600V 30A 2POLE FUSE HOLDER	1
10	ELATDR1/2	TIME DELAY FUSE 600V 1/2A	1

ELECTRICAL CONTACTOR AND OVERLOAD PARTS LIST

PART NO.	PHASE	MOTOR (HP)	VOLTAGE (V)	CONTACTOR PART NO.	OVERLOAD PART NO.
-	3	5	230	ELCI-32	ELT9E1/11-16
-			460	ELCI-12	ELT9E1/7-10
-		7.5	575	ELCI-9	ELT9E1/4.5-6.3
HW255E3CNG			230	ELCI-32	ELT9E1/20-25
HW2775E3CNG			460	ELCI-12	ELT9E1/11-16
			575	ELCI-12	ELT9E1/7-10



WIRING DIAGRAMS

HW255E1CNG

HW2775E1CNG

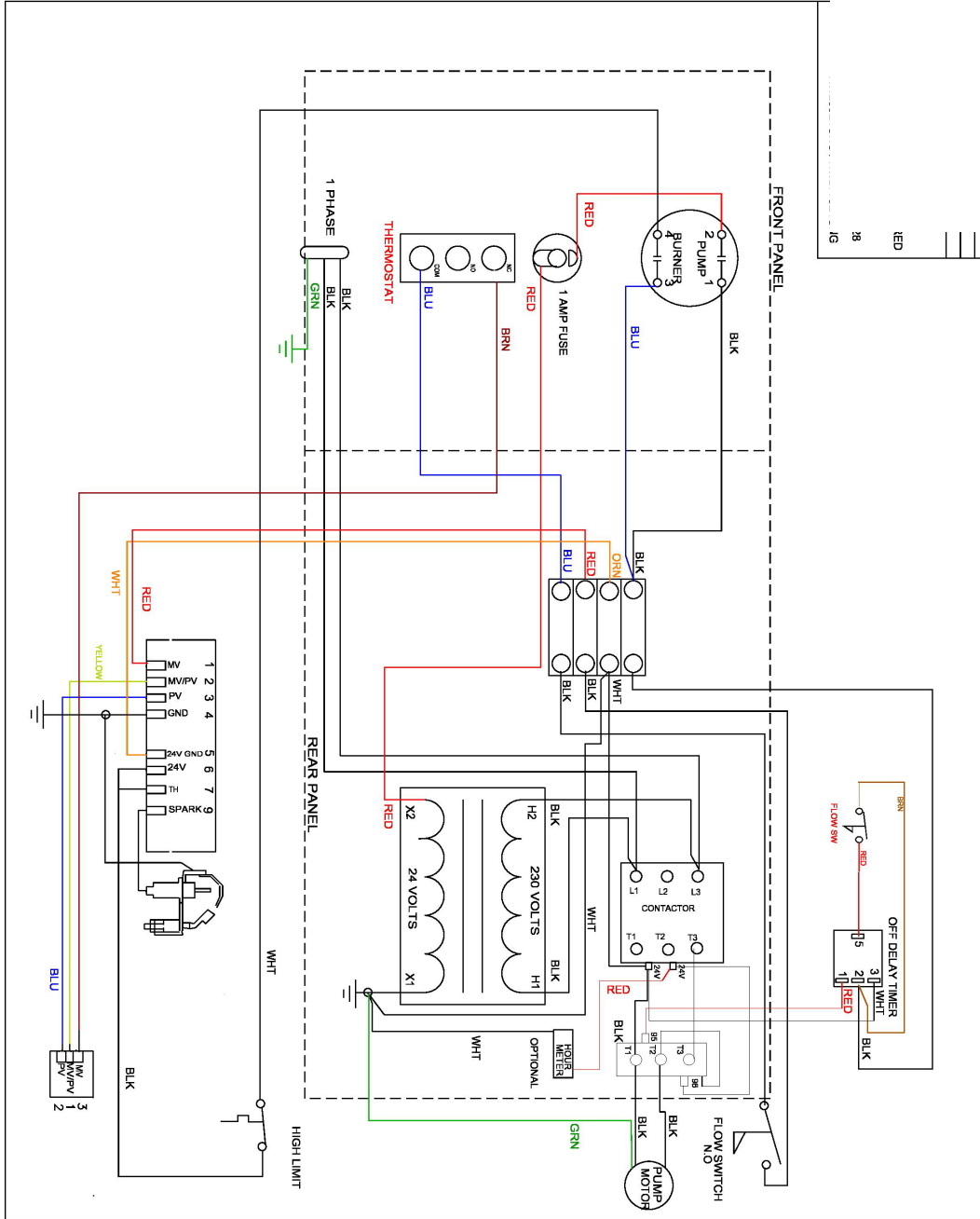

HW255E3CNG

HW2775E3NG

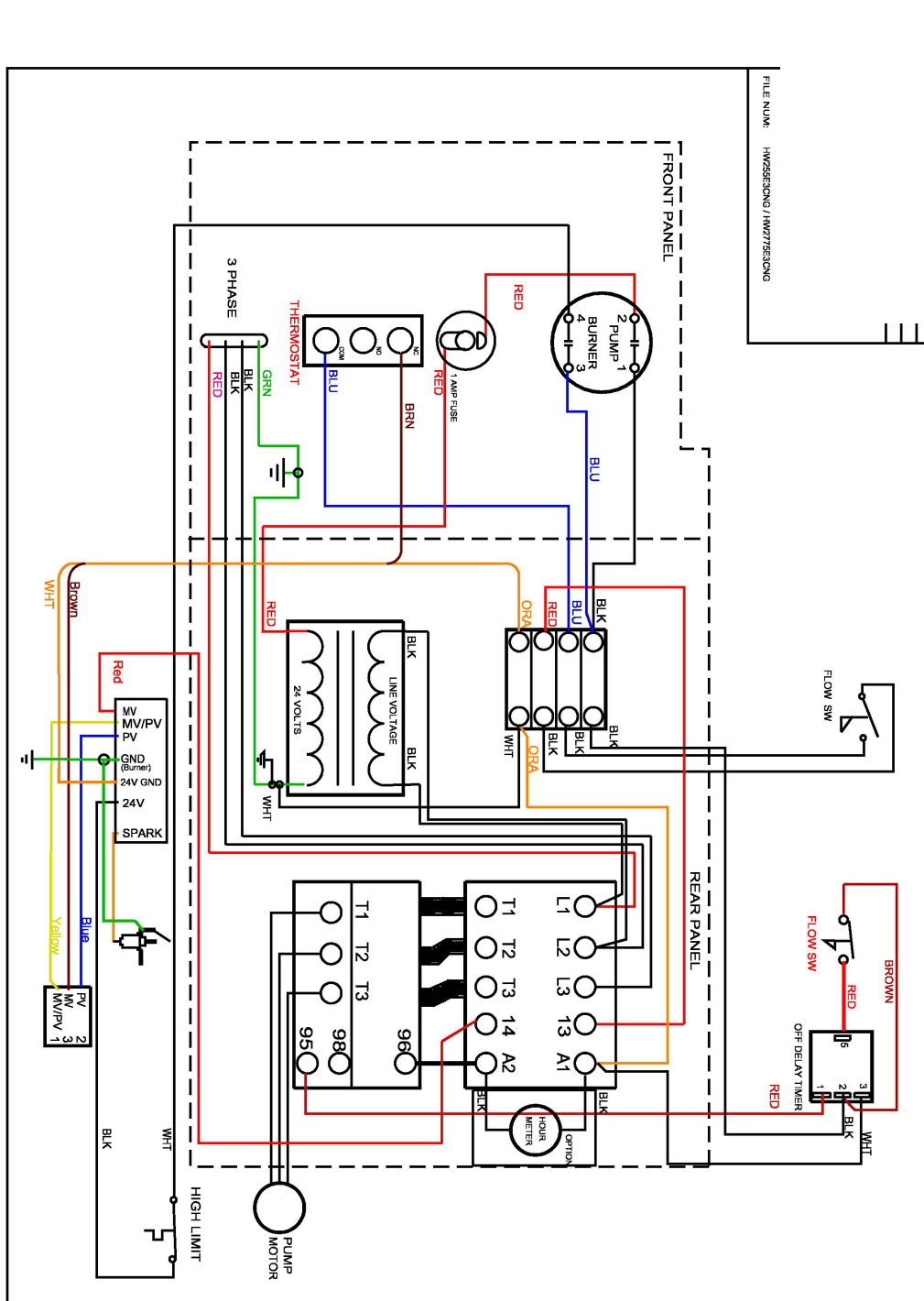



CLEAN HEATING COIL

Remove burner from coil by removing the four flange mount nuts. Inspect inside of combustion chamber and if it is heavily sooted so that air passage could be a serious problem, clean the air passage with a heavy duty vacuum. Run machine at full pressure and check the inside coil for leaks.

COIL MAINTENANCE

Liming of the coils is caused by mineral deposits from the water and occurs in hard water areas. The deliming procedure requires special caution and tools to perform. We recommend that you call your local service person if problems arise.

CHECKING FOR SCALE OR LIMING IN THE COIL:

- 1) Remove outlet orifice and check for any liming. Clean the orifice if needed.
- 2) Remove outlet gun and hose.
- 3) Install a pressure gauge between the unloader and coil inlet.
- 4) Turn on the pump without the water outlet gun or outlet orifice. If the pressure reading is above 50 psi, have your machine descaled. Else, reassemble the machine.

DESCALING

If pressure drop in the coil is over 50 psi - descaling is recommended. Descaling requires that use of highly corrosive chemicals. It also requires the use of goggles and special protective clothing.

- 1) This procedure requires a 20L pail of descaling chemical.
- 2) Plumb the pump suction into the pail of descaling compound with a screen on the end of the suction line.
- 3) Plumb a hose from the machine outlet back in the pail of descaling compound.
- 4) Turn the pump on and circulate the compound through the machine for about 20 minutes.
- 5) After that time the chemical being pumped out of the coil should be running thin and dirty rather than foaming heavily.
- 6) Remove the extra plumbing and reconnect machine together and run clean cold water through the machine for five minutes.



All parts manufactured by BE Power Equipment are warranted against defects and construction for 1 year and covered for 1 year labour.

Warranty does not include damage from negligence, abuse or freezing and is limited to the repair or replacement of the part(s).

Warranty part(s) will be repaired or replaced

FOB our factory or at any BE Power Equipment authorized depots, without charge, providing permission is first obtained from our factory and the part(s) returned prepaid. If onsite repairs are required, a labour charge will apply to the end user.

All parts will be repaired or replaced at BE Power Equipment's discretion.

COMPONENT	WARRANTY PERIOD	LABOUR
FABRICATED PARTS (Coil wrap, handle, frame, belt guard, etc.)	1 YEAR	1 YEAR
BURNER RING	1 YEAR	1 YEAR
TRANSFORMER	1 YEAR	1 YEAR
MISCELLANEOUS (Cords, electrodes, switches, fuel pumps, thermostats, etc.)	1 YEAR	1 YEAR

COIL WARRANTY

Any replacement during the warranty period will have a warranty of 1 year or the balance of the original warranty, whichever is greater.

BE Power Equipment will replace or repair the coil at BE Power Equipment 's discretion.

BE Power Equipment will not replace or repair coils under warranty if the coils have been subjected to misuse such as: **Freezing, Lime Deposit, Other Foreign Material deposit and vibration.**

COMPONENT	WARRANTY PERIOD	LABOUR
SCH 40	2 YEAR	1 YEAR
SCH 80	2 YEAR	1 YEAR
SCH 160	2 YEAR	1 YEAR
ELECTRIC	3 YEAR	1 YEAR



MAINTENANCE NOTES



BE

THE POWER YOU NEED



**IF YOU NEED ASSISTANCE WITH THE ASSEMBLY OR
OPERATION OF YOUR PRESSURE WASHER, PLEASE CALL**

1-866-850-6662

OR VISIT OUR WEBSITE:

BEPOWEREQUIPMENT

.COM